

# Installation Instructions

## Enviro Spike® Stainless Steel Bird Spike

Keep pigeons, seagulls, or larger birds from landing and roosting in unwanted areas with Bird•B•Gone® Enviro Spike® Stainless Steel Bird Spikes! Bird spikes are an effective, humane and cost-effective bird control solution that will not harm birds. Bird•B•Gone® Enviro Spike™ Stainless Steel Bird Spikes are ready to use and easy to install. No assembly required. Each bird spike strip comes pre-assembled in one foot sections, can be glued, screwed, or tied down to most surfaces and can easily be cut down into smaller lengths if needed.

**BIRD SPIKES ARE NOT RECOMMENDED IN AREAS WHERE BIRDS ARE NESTING.**

### APPLICATIONS

Enviro Spike® is a versatile system that can be easily glued, screwed, or tied down to various surfaces.

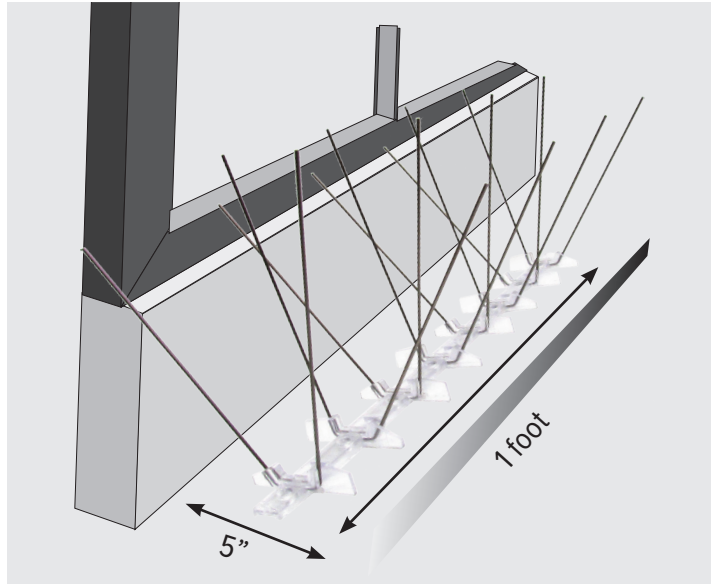

Bird Species	Pigeons, seagulls or larger birds
Bird Pressure	Light to Medium
Where to Use	Ledges, I-beams, parapet walls, conduits, signs, flat or curved surfaces

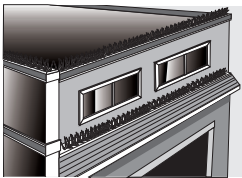

#### Ledges:

Enviro Spike® prevents pest birds from congregating on ledges, sills, roof tops, etc. Installing Enviro Spike® will stop birds from landing, roosting, and creating unsightly messes and health problems.

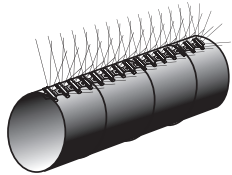

#### Conduit:

Enviro Spike® can be attached to wires, conduit, gutters, and pipes by using common hose clamps, nylon ties, wire, or glue.

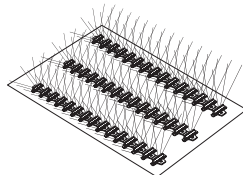

#### Large Flat Surface:

Enviro Spike® can be installed in multiple rows for a wider area of coverage.

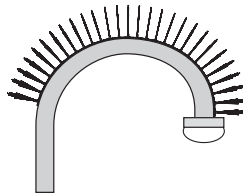

#### Curved Surfaces:

Enviro Spike® is so flexible that it can bend 360° without breaking. Install Enviro Spike® on all curved surfaces such as lampposts, signs, letters, etc. by using adhesive with nylon ties, hose clamps, etc.

### INSTALLATION QUESTIONS?

Call Bird•B•Gone® at 949.472.3122 or 800.392.6915

Email: [nobirds@birdbgone.com](mailto:nobirds@birdbgone.com)

Scan to watch our installation instruction videos:



# BIRD•B•GONE®

BIRDBGONE.COM | 800.392.6915

## Enviro Spike<sup>®</sup> Stainless Steel Bird Spike

**CAUTION: READ AND FOLLOW ALL INSTRUCTIONS PRIOR TO INSTALLATION. SPIKES ARE SHARP. WEAR GLOVES AND SAFETY EYE WEAR. KEEP OUT OF REACH OF CHILDREN AND PETS. DO NOT INSTALL WHERE HUMAN PHYSICAL CONTACT IS POSSIBLE. VISIT [BIRDBGONE.COM/SAFETY](http://BIRDBGONE.COM/SAFETY)**

### 1. DISINFECT AND CLEAN ALL SURFACE AREAS

Remove all debris including overhanging branches, leaves, nests, etc. Clean and disinfect area using hospital grade disinfectant. We recommend Microcide SQ™. Allow area to dry before installation. Visit [birdbgone.com/safety](http://birdbgone.com/safety) for additional information.

***DUE TO INFECTIOUS DISEASES ASSOCIATED WITH BIRD FECES, USE EXTREME CARE WHEN REMOVING NESTS AND BIRD DROPPINGS.***

### 2. DETERMINE THE METHOD OF ATTACHMENT

***For Concrete, Brick, Steel:*** Adhere bird spike strips using an outdoor construction-grade adhesive. Run a bead of adhesive down the underside of each bird spike strip. Press bird spike strip into place allowing the adhesive to mushroom-up for more effective adhesion. For a list of recommended adhesives, visit our website at [birdbgone.com](http://birdbgone.com).

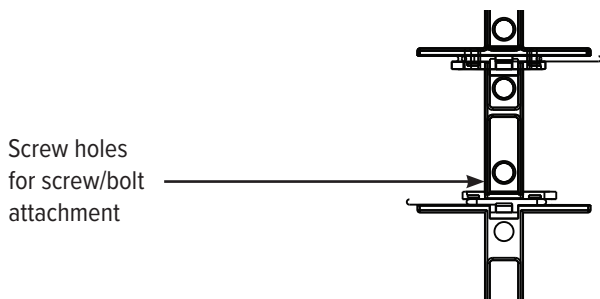

***For Wood:*** Use wood screws to secure bird spike strips to wood surfaces. Following pre-drilled holes along the strip base, screw into the end of each bird spike strip tightly; place one wood screw at least every six inches along the strip base.

***Tie Down:*** For pipes and other areas, secure bird spike strips with nylon ties by wrapping and securing the tie around the base of the bird spike strip.

**NOTE: WHENEVER POSSIBLE, BIRD SPIKE STRIPS SHOULD BE SCREWED OR BOLTED DOWN IN CONJUNCTION WITH THE USE A NON-SILICONE OUTDOOR CONSTRUCTION-GRADE ADHESIVE.**

### 3. SPIKE PLACEMENT

- To prevent birds from nesting behind the spike, leave no more than 1" gap between the wall and the bird spike strip.
- To prevent birds from sitting on the ledge, leave a minimum of 1/2" overhang between the tip of the bird spike and front/leading edge.

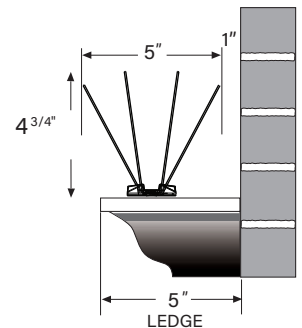

- For wide areas, multiple rows of bird spike strips may need to be installed. Install bird spike strips with 1" overlap.

### 4. ADAPTING TO SIZE

- Enviro Spike<sup>®</sup> can be easily cut to desired size using tin snips, wire cutters, or snapped apart by hand along the narrow section of the bird spike strip base.

### INSTALLATION QUESTIONS?

Call Bird•B•Gone<sup>®</sup> at 949.472.3122 or 800.392.6915  
Email: [nobirds@birdbgone.com](mailto:nobirds@birdbgone.com)

Scan to watch our installation instruction videos:



[BIRDBGONE.COM](http://BIRDBGONE.COM) | 800.392.6915