

Havahart® Spray Away™ Sprinkler Repellent Owner's Manual Model #5266

Havahart® Total Yard Protection

Check out our other Havahart® brands online. Visit www.Havahart.com to learn more.



Critter Ridder® is a powerful, all-natural, multi-species animal repellent. The patented formula combines three different types of pepper to irritate the animal's sense of taste, smell and touch to drive them away from protected areas.



Deer Off® uses a Dual Deterrent System that repels deer, rabbits, and squirrels by odor and taste. The odor of putrescent egg mimics the scent of a dead animal, and the taste of garlic and capsaicin irritate the animal to stop it from feeding on your plants.



DeFence® stops rabbits and deer from eating your plants and garden. The scent of putrescent egg mimics the scent of a dead animal, and signals a predator is nearby, causing the animal to flee the area.

Get the latest news, expert tips, and deals!

Follow us on:



www.Havahart.com

Owner's Manual

*Thank you for purchasing the
Havahart® Spray Away™ Sprinkler Repellent!*



<u>CONTENT</u>	<u>PAGE</u>
<i>Cautionary Reminders</i>	<i>2</i>
<i>How It Works</i>	<i>3</i>
<i>Components</i>	<i>4</i>
<i>Assembly Guide</i>	<i>5</i>
<i>Placement Guide</i>	<i>6</i>
<i>Sensitivity Guide</i>	<i>7</i>
<i>Adjusting Water Coverage</i>	<i>8</i>
<i>Troubleshooting</i>	<i>9</i>
<i>Warranty</i>	<i>10</i>

Woodstream® Corporation
69 North Locust Street
Lititz, PA 17543
United States
www.Havahart.com

If you encounter any problems while assembling your Spray Away™, please refer to the Troubleshooting section of this manual or call us at 1.855.5.HAVAHART. We're also available for live chat online at www.Havahart.com.

Cautionary Reminders

- ⚠ Intended to operate with typical household water pressure—between 30 and 80 psi.
- ⚠ When pushing the stake into the ground, use the step-in-stake footstep. DO NOT push down or apply weight on the unit.
- ⚠ To prevent damage from freezing water, take Spray Away™ inside when the temperature drops below 32°F.
- ⚠ Dust, dirt or hard water can limit sensitivity. Keep Infrared Sensor clean by wiping gently with a damp cloth.
- ⚠ Before disconnecting hose from unit, turn water off and activate unit with hand to drain hose.
- ⚠ A maximum sensitivity level is more prone to have repeated/false triggers.
- ⚠ To minimize false triggers, avoid pointing Spray Away™ at moving water, windy areas and moving vehicles.
- ⚠ Spray Away™ may frighten small birds.

DO NOT PUSH DOWN ON UNIT!

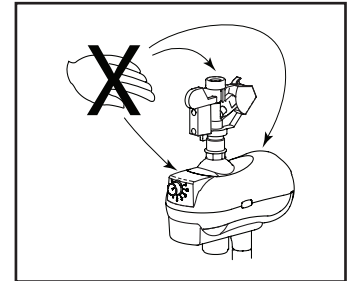

MAY FRIGHTEN BIRDS!

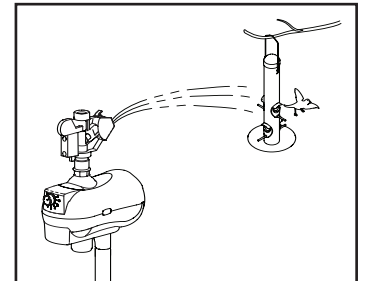

How It Works

Havahart® Spray Away™ Motion Activated Sprinkler Repellent provides an innovative, humane way to keep unwanted animals out of your yard and garden. Sensing animals of all sizes, Spray Away™ provides an environmentally-friendly and safe alternative to chemical repellents and electric fences. Spray Away™ uses an infrared sensor to detect the animal, and then deploys a burst of water combined with unexpected noise and motion to create a safe and effective deterrent.

Spray Away™ features an **Adjustable Sensor Eye**, which adjusts to sense a variety of different animal sizes. Adjust the eye up to scare birds and large animals, and down for smaller animals. The eye is also useful to adjust to varying slope changes and different terrain. This feature gives you a wider range of coverage to protect your yard and garden from a variety of animals on different terrain and in many different locations.

Spray Away™'s **Step-In Stake** design makes it easy to stake the unit into the ground using a footstep.

Spray Away™ is powerful enough to protect up to 1900 square feet while detecting motion 35 feet in front of the unit. Whether you have a deer or rabbit snacking on plants, or a heron stealing fish from your pond, the versatile Spray Away™ will condition these critters to find lunch elsewhere!

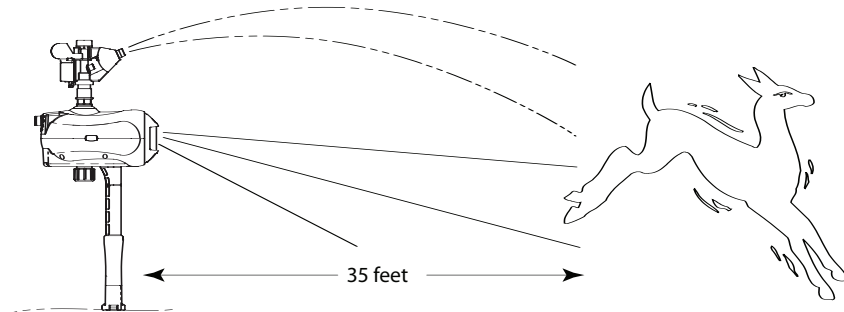

Components

Missing Something? Call us at 1.855.5.HAVAHART!

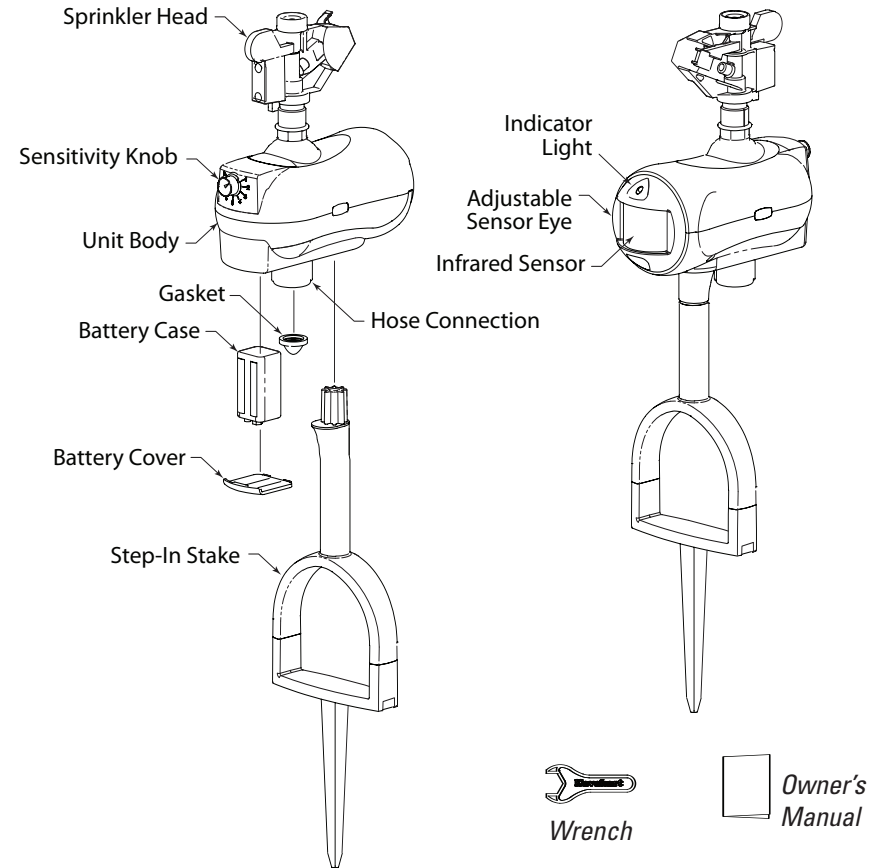

What you will need:

Garden Hose

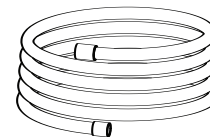

Access to Tap

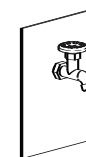

4 AA Batteries

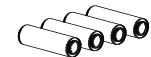

Assembly Guide

Placement Guide

1. Attach Sprinkler Head

- Attach Sprinkler Head by hand to the top of Unit Body.
- Fully tighten Sprinkler Head by turning clockwise with the provided plastic Wrench.

Note: Using tools other than the provided wrench could damage the unit and result in leaking and malfunction.

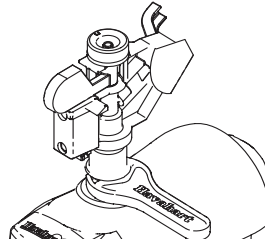

2. Install 4 AA Batteries into Battery Case

- Battery case is located under Unit Body.
- If Indicator Light is blinking continuously every 3 seconds, batteries are low.

Note: Indicator Light will flash once when movement is sensed.

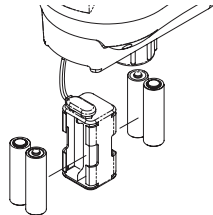

3. Check Spray Away™ Operation (Dry Test: Do NOT attach hose!)

- Turn Sensitivity Knob on back of unit to level 5.
- Wait 5 seconds, then wave hand in front of Infrared Sensor.
- Spray Away™ will make a "click" or motor sound and Indicator Light will illuminate. Spray Away™ will reset for 8 seconds between activation and will not detect motion.

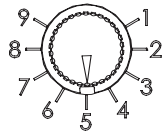

Note: If you do not hear sound, try new batteries and try hooking your unit up to water. If the problem persists, call us toll-free at 1.855.5.HAVAHAART or live chat at www.Havahart.com.

4. Assemble Step-in-Stake and attach to Unit Body

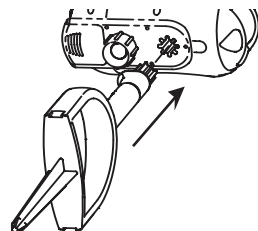

1. Find the Ideal Location

- Place Spray Away™ in area in which animals will cross the Detection Range.
- Place the unit so that the Unit Body is level to the ground, and the Infrared Sensor is facing the area to be protected.

Detection Range

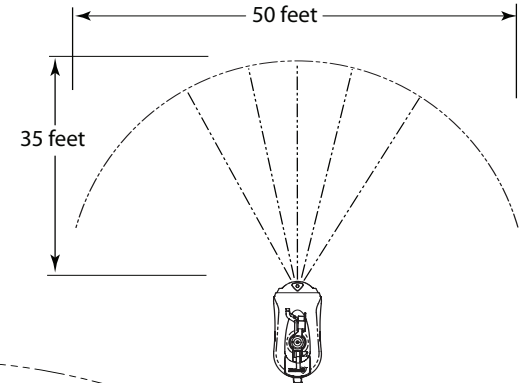

Spray Distance

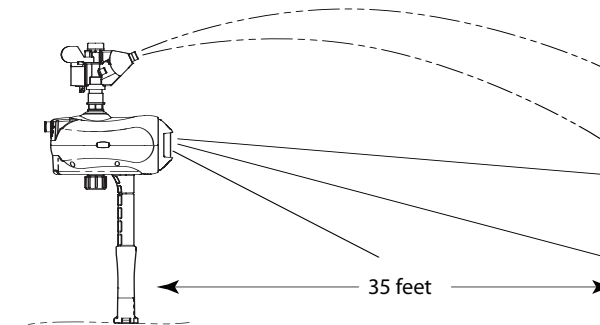

Note: Spray distance varies as it is directly related to your hose water pressure.

2. Stake Spray Away™ into Ground

- If ground is too hard or unsuitable for Step-in-Stake, try wetting ground to soften soil, or stake Spray Away™ in a bucket or flowerpot filled with sand or gravel.
- Do NOT push on top of Sprinkler Head or Unit Body.

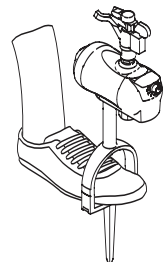

Sensitivity Guide

1. Setting the Sensitivity

- Using the Suggested Settings Chart, adjust the *Sensitivity Knob* accordingly.



Setting the Sensitivity in Temperatures BELOW 80 degrees F

Animal Size	Distance		
	10 Feet	20 Feet	30 Feet
Small	7	8*	8*
Medium	5	6	7
Large	2	2	3

Setting the Sensitivity in Temperatures ABOVE 80 degrees F

Animal Size	Distance		
	10 Feet	20 Feet	30 Feet
Small	9	9*	9*
Medium	8	9	9
Large	4	5	6

*Some small animals may not be seen at this distance

Because Spray Away™ detects heat, the sensitivity must be set higher in warmer temperatures. Please use the appropriate chart when temperatures reach 80 degrees F+.

Note: in warmer temperatures, along with using higher sensitivity settings, the risk of false triggering is higher. The sensitivity should be turned down in the case of false triggers.

2. Adjust Sensor Eye

- Up: if terrain inclines in front of unit, or for sensing large animals
- Down: if terrain descends in front of unit, or for sensing small animals
- Use palm of hand to change position of sensor eye. Do NOT push directly on lens—it will damage the unit.

3. Testing the Sensitivity

- Start outside your desired coverage area and walk across path in front of Spray Away™.
- Spray Away™'s Indicator Light will illuminate for 3 seconds when it senses you.
- Spray Away™ will reset for 8 seconds between activations and will not detect.
- Repeat this process until you are satisfied with Spray Away™'s coverage area.

DETERMINE COVERAGE AREA

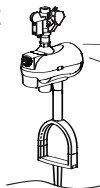

INDICATOR LIGHT FLASHES WHEN SENSING



Adjusting Water Coverage

1. Position Stem Tabs to Adjust Sprinkler Travel

- Set the sprinkler's spray pattern to direct the water towards the desired protection area.

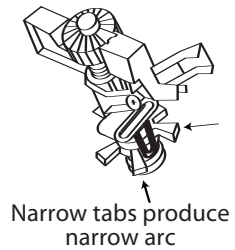
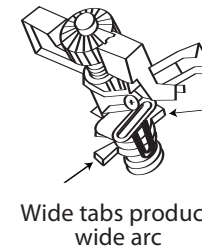
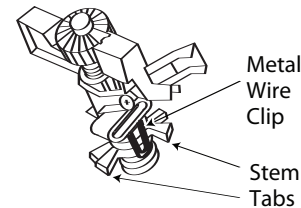

2. Adjust the Distance of Water Spray

Maximum

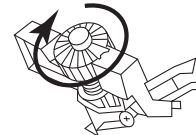

Clockwise increases spray distance

Minimum

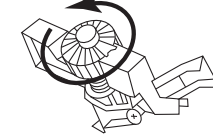

Counter-clockwise reduces spray distance

3. Attach Hose

- Attach the hose to the Hose Connection at the bottom of the Unit Body.

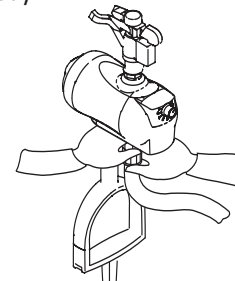

4. Turn water ON & test from behind

- Turn ON water.
- Stand behind Spray Away™ and wave your hand in front of the Infrared Sensor. Adjust the arc and distance as needed.

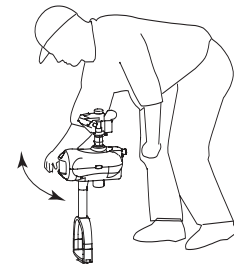

Troubleshooting

If you encounter any problems with *Spray Away™*, please call us at 1.855.5.HAVAHART.

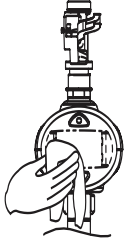
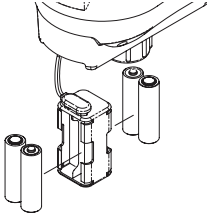
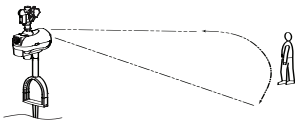
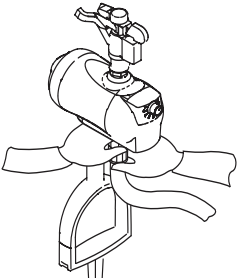
Problem	Solutions	Illustration
<i>Spray Away™ does not 'see' animals</i>	<p>Re-aim <i>Spray Away™</i>.</p> <p>Clean Infrared Sensor with damp cloth.</p> <p>On extremely hot days, Infrared Sensor may not detect animal's heat. Please refer to the chart on page 7 to determine the sensitivity in temperatures of 80° F+.</p>	
<i>Spray Away™ is not spraying, or is only lightly spraying</i>	<p>If Indicator Light is blinking continuously every 3 seconds, change batteries.</p> <p>Water pressure from faucet tap may be too low. Tighten Sprinkler Head and Hose Connection.</p>	
<i>Unit is activating when no animal is present</i>	<p><i>Spray Away™</i> is sensing movement. Reduce sensitivity and re-test the sensing area as explained in the instructions on page 7.</p>	
<i>Unit is leaking</i>	<p>Check to be sure unit is free from debris at hose connection.</p> <p>Ensure hose thread is not damaged.</p> <p>Make sure hose and sprinkler are tightly secured.</p> <p>Hose pressure could be too high if over 80 psi.</p>	

Warranty

This warranty, two (2) years from the purchase of the unit, is extended only to the original purchaser/user of products.

Woodstream Corp. warrants its products to be free from defects in materials and workmanship for the warranty period by the original purchaser/user.

For warranty service, please contact our Customer Service at (855) 5-HAVAHART. Please indicate the nature of the defect.

If Woodstream Corp. determines there may be a defect, Woodstream Corp. will issue a Return Goods Authorization (RGA) number. The defective unit or parts must be returned for warranty inspection using the RGA number, when applicable, as identification within (30) days of return authorization date. DO NOT return products to our factory without our prior consent, as they, as well as C.O.D. shipments will be refused. Woodstream Corp., at its option, shall replace the unit, or replace the defective part(s) and return such unit to you. Woodstream Corp.'s sole obligation and your exclusive remedy under this warranty shall be limited to such replacement.

Limitations and Exclusions: The warranty shall not apply to problems arising from normal wear, or failure to adhere to the enclosed instructions. In addition, the foregoing warranty shall not apply to serial numbered products if the serial number has been removed or defaced; products subject to negligence, accident, improper operation, maintenance or storage; products damaged by circumstances beyond Woodstream Corp.'s control; or products modified (including, but not limited to modifications through the use of unauthorized parts or attachments) or repaired by anyone other than Woodstream Corp. or its designee.

The foregoing warranty is exclusive and in lieu of all other warranties, express or implied, including without limitation the implied warranties of merchantability and fitness for a particular purpose. It shall not extend beyond the duration of the express warranty provided herein, and the remedy for violations of any warranty shall be limited to repair or replacement of the defective product pursuant to the terms contained herein. Woodstream Corp. shall not be liable for any consequential or incidental damages whatsoever.

This warranty gives you specific legal rights and you may also have other legal rights which may vary based on location.

Register your product online at:
www.Havahart.com/customerservice/product-registration